

TECWARE

nexus **AIR**  
**M3**

HIGH AIRFLOW MATX TEMPERED GLASS CASE

Quick Start Guide

# Contents

◆ Specification -----	p.01
◆ Front Cover -----	p.02
◆ Front Panel I/O Connections -----	p.03
◆ Component List -----	p.04
◆ Motherboard Installations -----	p.05
◆ SSD Installation -----	p.06
◆ HDD Installation Steps -----	p.07
◆ GPU & PSU Installation -----	p.08
◆ Cable Management Area -----	p.09
◆ CPU Cooler / Fan Installation -----	p.10
◆ Package Contents & Warranty -----	p.11

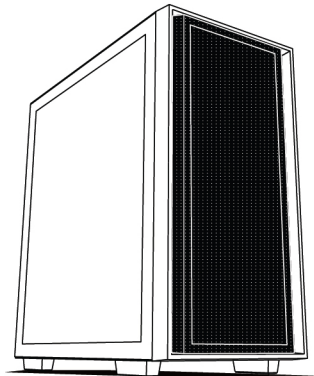

## Specifications

Type	Specification
Motherboard Support	ITX, mATX
Dimensions	397(L) x 198(W) x 410(H) mm
3.5" HDD Drive Bay	2
2.5" SSD Drive Bay	2
Expansion Slots	4
Maximum GPU Length	330mm
Maximum PSU Length	180mm
Maximum CPU Cooler Height	159mm

## Front Cover

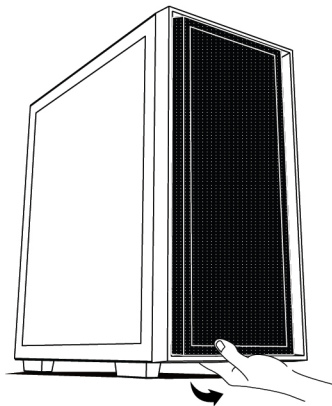

Open the front cover by pulling outwards to the right.

## Front Panel I/O Connections

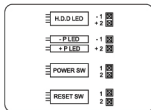

### BUTTONS AND ACTIVITY LIGHTS

---

These cables are connected to the motherboard for the power button ( power sw ), reset button, HDD LED, and power LED ( P+ / P- ).

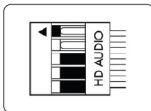

### HD AUDIO

---

This connector attaches to your sound card or motherboard and is used to provide the front panel mic input and headphone output.

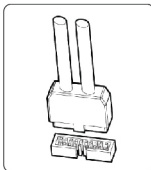







### USB 3.0 CONNECTOR

---

This cable connects to the USB 3.0 header on the motherboard to enable the front USB 3.0 ports.

## Component List

VISUAL	ITEM	QTY	APPLICATION
A 	Motherboard & SSD screw	23	Motherboard and 2.5 hard drive installation
B 	Motherboard standoff	3	Motherboard installation
C 	HDD mount screw	8	3.5 hard drive installation
D 	PSU & Rear expansion slot screw	7	Power supply installation Mounting of GPU and other expansion cards
E 	Radiator Fan Screw	8	Radiator/Fan Installation
F 	Cable Tie	6	Cable management

## Motherboard Installation

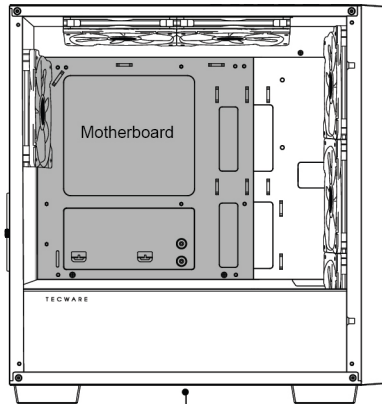

Screw Type A & B

## SSD Installation

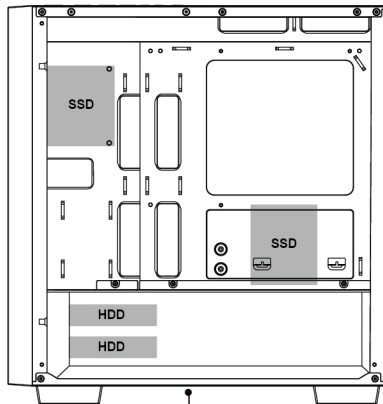

Screw Type A & C



# GPU & PSU Installation

Graphics Processing Unit and other expansion cards

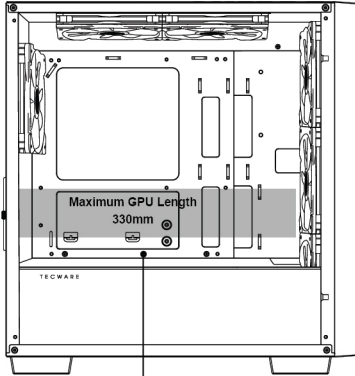

Power Supply Unit Installation

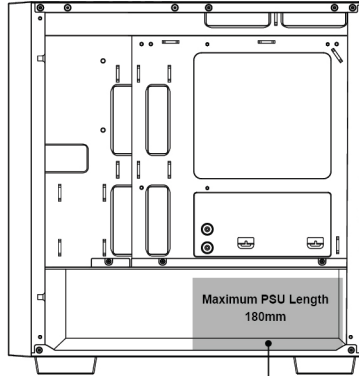

Screw (Type D)

## CPU Cooler / Fan & Radiator Installation

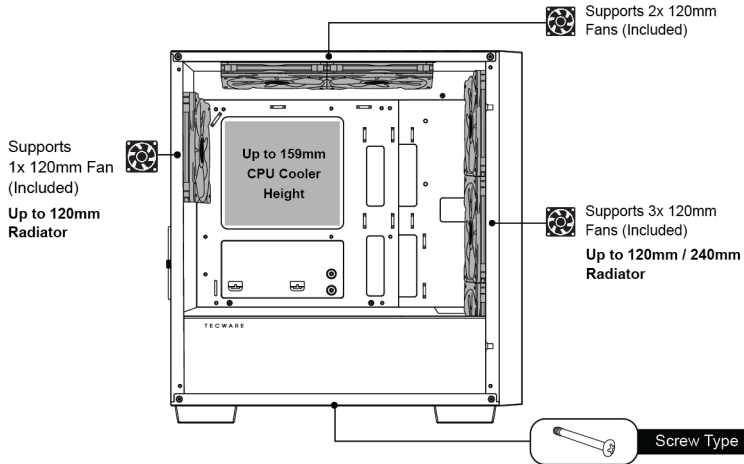

## **Package Contents**

- 1 x TECWARE Nexus Air M3 Case
- 1 x Accessories Box

## **Warranty**

- 1 Year. Please contact your local distributor for support.



TECWARE

[www.tecware.co](http://www.tecware.co)