



VXM

DUAL CHAMBER SFF CASE

MESH

Quick Start Guide

Contents

| | |
|---------------------------------------|------|
| ◆ Specification | p.01 |
| ◆ Panel Removal | p.02 |
| ◆ Front Panel I/O Connections | p.03 |
| ◆ Component List | p.04 |
| ◆ Motherboard Installations | p.05 |
| ◆ SSD / HDD Installation | p.06 |
| ◆ GPU & PSU Installation | p.07 |
| ◆ CPU Cooler / Fan Installation | p.08 |
| ◆ Package Contents & Warranty | p.09 |

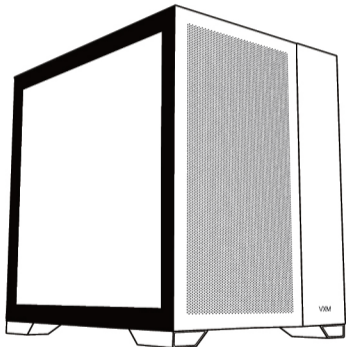

Specifications

| Type | Specification |
|---------------------------|-----------------------------|
| Motherboard Support | mATX, ITX |
| Dimensions | 338(L) x 255(W) x 335(H) mm |
| 3.5" HDD Drive Bay | 1 |
| 2.5" SSD Drive Bay | 3 |
| Expansion Slots | 4 |
| Maximum GPU Length | 320mm |
| Maximum CPU Cooler Height | 140mm |
| Maximum PSU Length | 160mm |

Panel Removal

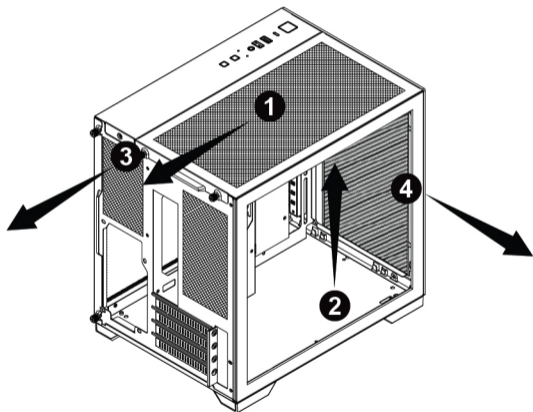

Front Panel I/O Connections

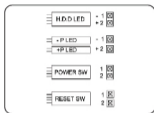

BUTTONS AND ACTIVITY LIGHTS

These cables are connected to the motherboard for the power button (power sw), reset button, HDD LED, and power LED (P+ / P-).

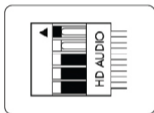

HD AUDIO



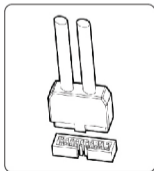

This connector attaches to your sound card or motherboard and is used to provide the front panel mic input and headphone output.



USB 3.0 CONNECTOR

This cable connects to the USB 3.0 header on the motherboard to enable the front USB 3.0 ports.

Component List

| VISUAL | ITEM | QTY | APPLICATION |
|---|---------------------------------|-----|--|
| A  | Motherboard & SSD screw | 10 | Motherboard and 2.5 hard drive installation |
| B  | Motherboard standoff | 3 | Motherboard installation |
| C  | HDD mount screw | 4 | 3.5 hard drive installation |
| D  | PSU & Rear expansion slot screw | 5 | Power supply installation Mounting of GPU and other expansion cards |
| E  | Cable tie | 7 | Cable management |

Motherboard Installation

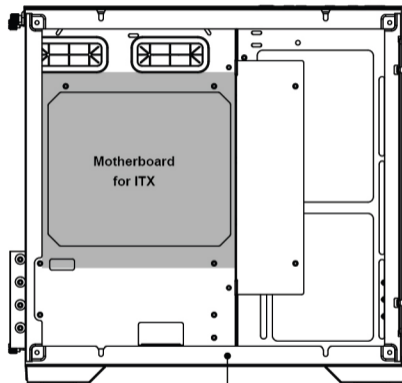
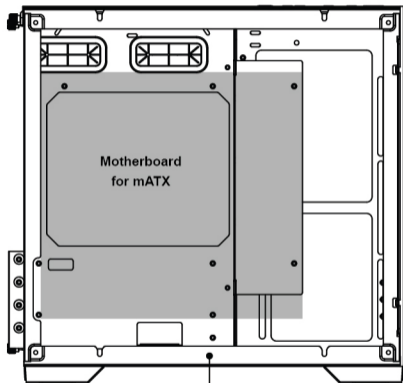

Screw (Type A & B)

SSD / HDD Installation

SSD Drive Installation

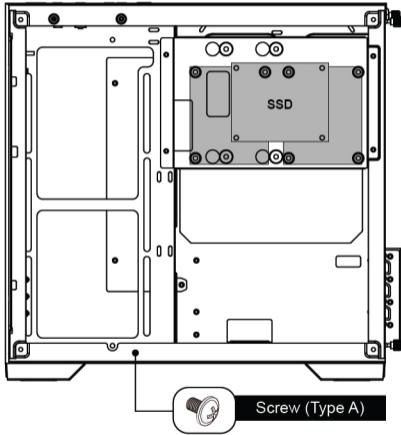

HDD Drive Installation

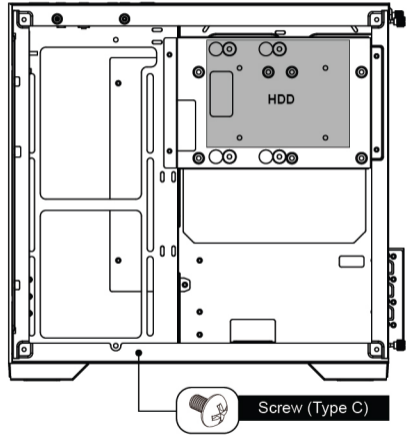

GPU & PSU Installation

Graphics Processing Unit and other expansion cards

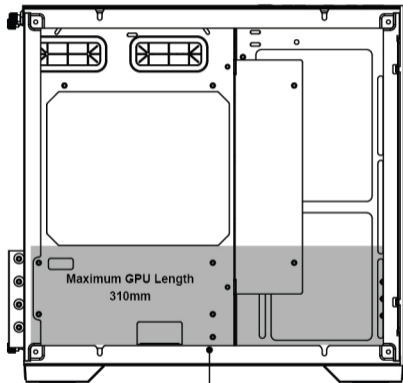

Power Supply Unit Installation

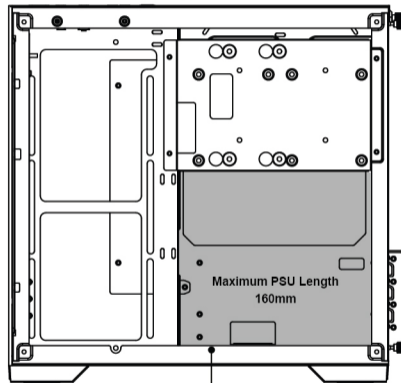

Screw (Type D)

CPU Cooler / Fan Installation

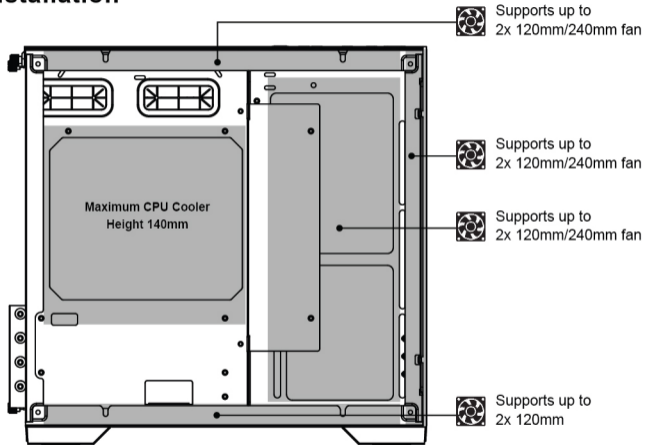

Package Contents

- 1 x TECWARE VXM Case
- 1 x Bag of Accessories

Warranty

- 1 Year. Please contact your local distributor for support.

T E C W A R E

www.tecware.co