

TECWARE

nexus **AIR**
T3

COMPACT MATX TEMPERED GLASS CASE

Quick Start Guide

Contents

| | |
|---------------------------------|------|
| ◆ Specification | p.01 |
| ◆ Front Cover | p.02 |
| ◆ Front Panel I/O Connections | p.03 |
| ◆ Component List | p.04 |
| ◆ Motherboard Installations | p.05 |
| ◆ SSD Installation | p.06 |
| ◆ HDD Installation Steps | p.07 |
| ◆ GPU & PSU Installation | p.08 |
| ◆ Cable Management Area | p.09 |
| ◆ CPU Cooler / Fan Installation | p.10 |
| ◆ Package Contents & Warranty | p.11 |

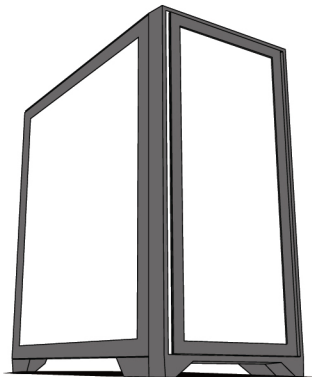

Specifications

| Type | Specification |
|---------------------------|-----------------------------|
| Motherboard Support | ITX, mATX |
| Dimensions | 398(L) x 198(W) x 412(H) mm |
| 3.5" HDD Drive Bay | 2 |
| 2.5" SSD Drive Bay | 2 |
| Expansion Slots | 4 |
| Maximum GPU Length | 330mm |
| Maximum PSU Length | 180mm |
| Maximum CPU Cooler Height | 159mm |

Front Cover

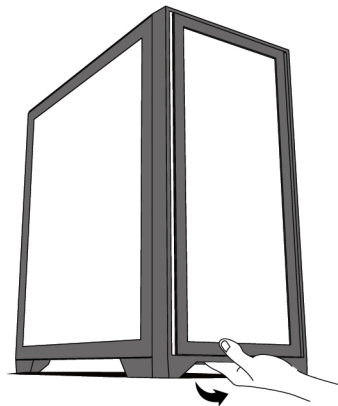

Open the front cover by pulling outwards to the right.

Front Panel I/O Connections

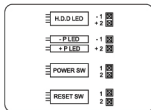

BUTTONS AND ACTIVITY LIGHTS

These cables are connected to the motherboard for the power button (power sw), reset button, HDD LED, and power LED (P+ / P-).

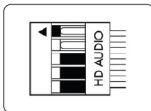

HD AUDIO



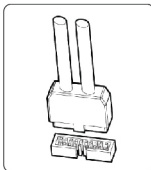



This connector attaches to your sound card or motherboard and is used to provide the front panel mic input and headphone output.



USB 3.0 CONNECTOR

This cable connects to the USB 3.0 header on the motherboard to enable the front USB 3.0 ports.

Component List

| VISUAL | ITEM | QTY | APPLICATION |
|---|---------------------------------|-----|--|
| A  | Motherboard & SSD screw | 23 | Motherboard and 2.5 hard drive installation |
| B  | Motherboard standoff | 3 | Motherboard installation |
| C  | HDD mount screw | 8 | 3.5 hard drive installation |
| D  | PSU & Rear expansion slot screw | 7 | Power supply installation Mounting of GPU and other expansion cards |
| E  | Radiator Fan Screw | 8 | Radiator/Fan Installation |
| F  | Cable Tie | 6 | Cable management |

Motherboard Installation

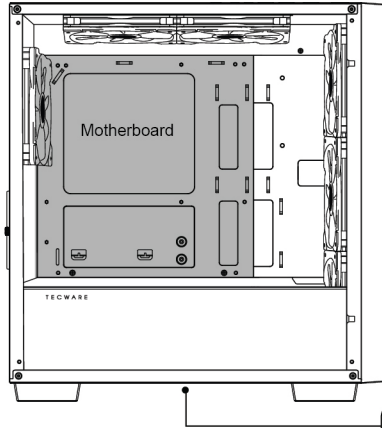

Screw Type A & B

SSD Installation

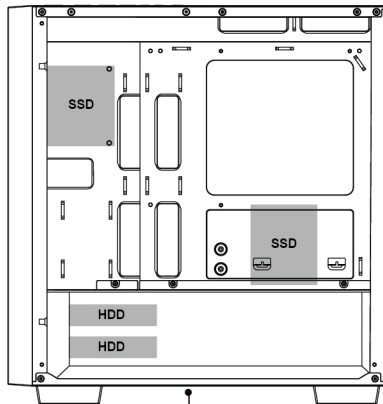

Screw Type A & C

GPU & PSU Installation

Graphics Processing Unit and other expansion cards

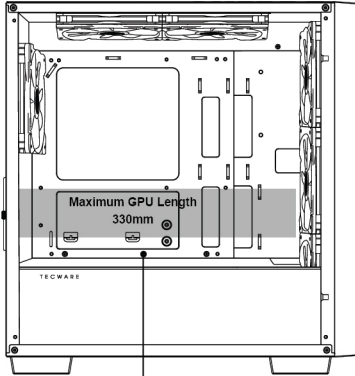

Power Supply Unit Installation

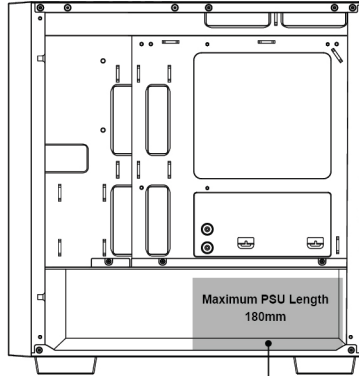

Screw (Type D)

CPU Cooler / Fan & Radiator Installation

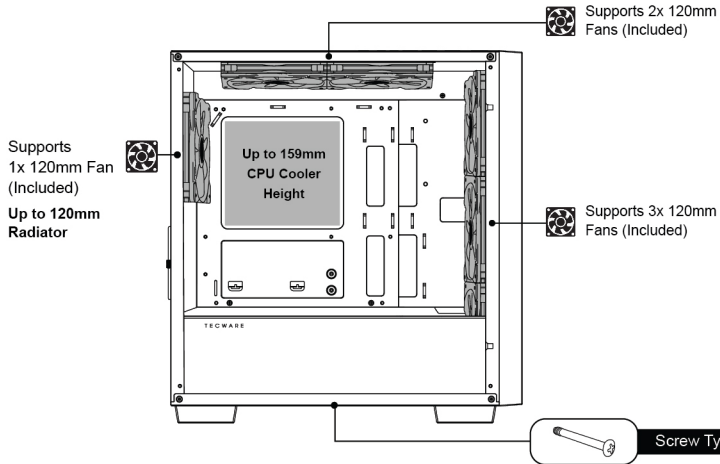

Package Contents

- 1 x TECWARE Nexus Air T3 Case
- 1 x Accessories Box

Warranty

- 1 Year. Please contact your local distributor for support.

TECWARE

www.tecware.co