

TECWARE

# EDGE M2

HIGH AIRFLOW COMPACT MATX CASE

Quick Start Guide

# Contents

◆ Specification .....	p.01
◆ Front Cover .....	p.02
◆ Front Panel I/O Connections .....	p.03
◆ Component List .....	p.04
◆ Motherboard Installations .....	p.05
◆ SSD Installation .....	p.06
◆ GPU & PSU Installation .....	p.07
◆ CPU Cooler / Fan Installation .....	p.08
◆ Package Contents & Warranty .....	p.09

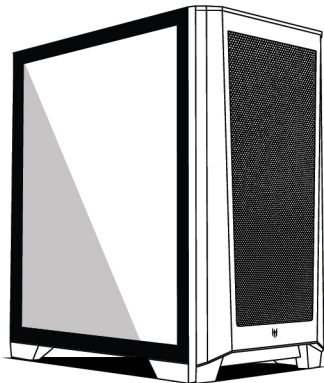

## Specifications

Type	Specification
Motherboard Support	ITX, mATX
Dimensions	367(L) x 216(W) x 405(H) mm
3.5" HDD Drive Bay	2
2.5" SSD Drive Bay	2
Expansion Slots	4
Maximum GPU Length	330mm
Maximum PSU Length	160mm
Maximum CPU Cooler Height	175mm

## Front Cover

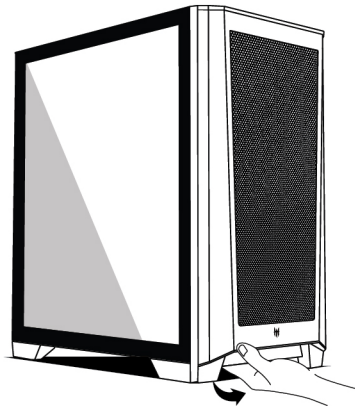

Open the front cover by pulling outwards with controlled force.

## Front Panel I/O Connections

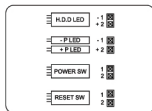

### BUTTONS AND ACTIVITY LIGHTS

---

These cables are connected to the motherboard for the power button ( power sw ), reset button, HDD LED, and power LED ( P+ / P- ).

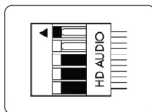

### HD AUDIO

---

This connector attaches to your sound card or motherboard and is used to provide the front panel mic input and headphone output.

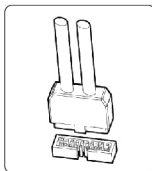

### USB 3.0 CONNECTOR





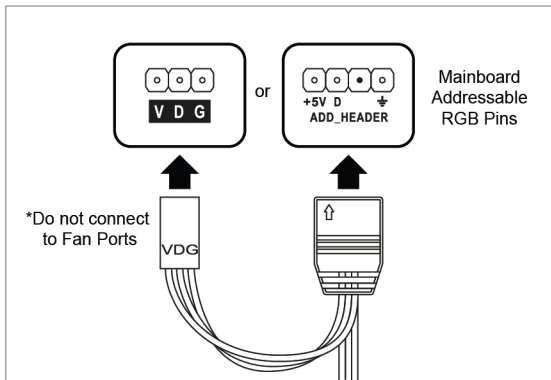

---

This cable connects to the USB 3.0 header on the motherboard to enable the front USB 3.0 ports.

## Fan ARGB Connections



## Component List

VISUAL	ITEM	QTY	APPLICATION
A 	Motherboard & SSD screw	23	Motherboard and 2.5 hard drive installation
B 	Motherboard standoff	3	Motherboard installation
C 	HDD mount screw	8	3.5 hard drive installation
D 	PSU & Rear expansion slot screw	7	Power supply installation Mounting of GPU and other expansion cards
E 	Radiator Fan Screw	8	Radiator/Fan Installation
F 	Cable Tie	6	Cable management

## Motherboard Installation

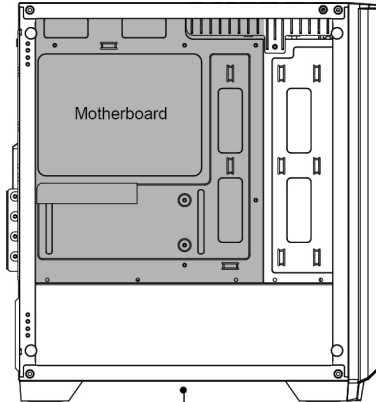

Screw Type A & B



## SSD Installation

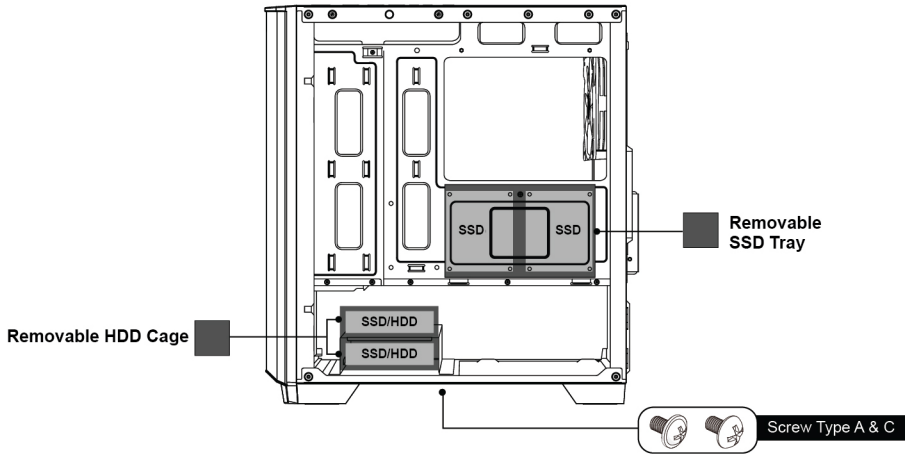

## GPU & PSU Installation

Graphics Processing Unit and other  
expansion cards

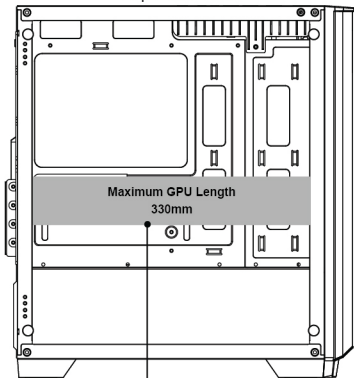

Power Supply Unit Installation

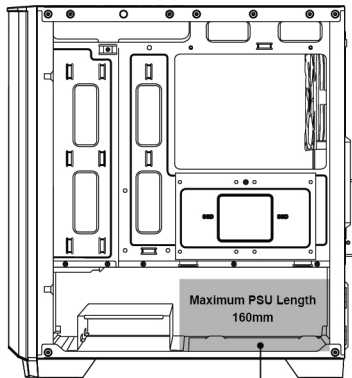

Screw (Type D)

## CPU Cooler / Fan & Radiator Installation

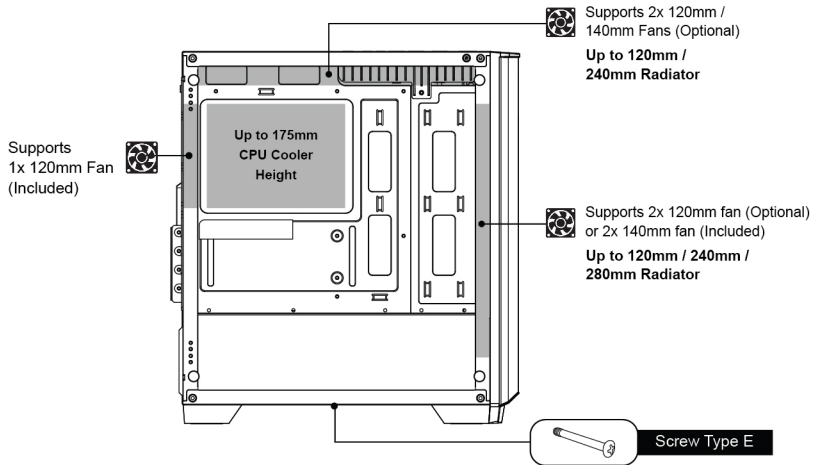

## **Package Contents**

- 1 x TECWARE Edge M2 Case
- 1 x Accessories Box

## **Warranty**

- 1 Year. Please contact your local distributor for support.

T E C W A R E

[www.tecware.co](http://www.tecware.co)